



## Freestanding Solid Surface Bathtubs



**Solid Surface**

### Installation Instructions and Operation Manual

**Rev-5/21**

**Installer: This booklet must be given to the product owner.**

**Please note important information below:**

Distributor Name & Location: \_\_\_\_\_

Model Number: \_\_\_\_\_

Date of Purchase: \_\_\_\_\_

## Owner's Manual and Installation Guide

Thank you for choosing a Hastings Bath Tub. You have purchased the best-built freestanding solid surface bathtubs made in America. We know it will give you many years of pleasure. The instructions in this booklet will provide you with the information you need to install and operate this unit. This information is also available online at [www.hastingstilebath.com](http://www.hastingstilebath.com) Our customer service department is available to answer any additional questions you may have relating to the installation and operation of your bath. Call 800-351-0038 to speak to our Customer Service representative. Please have your model number and order information available when calling.

### Important Safety Instructions

**Warning: When using this product, basic precautions should be followed as noted below:**

This manual contains information and instructions for proper operation and maintenance of your Hastings bathtub. Failure to follow these instructions could result in personal injury or electric shock.

### Read and Follow All Instructions

#### Instructions Regarding Risk of Fire, Shock, or Personal Injury

- ▶ Do not permit children to use this unit unless they are closely supervised by an adult at all times. Supervision should also be provided when the bath is used by an elderly or handicapped individual.
- ▶ Use this unit only for its intended use as described in this manual. Do not use attachments not authorized by the manufacturer.
- ▶ The water in a solid surface bath should never exceed 38°C (100°F). Water temperatures up to 38°C (100°F) are considered to be safe for a healthy adult. Use time at these higher temperatures should be limited to approximately 15 minutes. Lower water temperatures are recommended for extended use (exceeding 15 minutes) and for young children. Longer exposures may result in hyperthermia, which can be fatal. The symptoms of this condition are nausea, dizziness, and fainting.

Effects of hypothermia include:

- 1) Unawareness of impending hazard
- 2) Failure to perceive amount of heat
- 3) Failure to recognize the need to exit the bathtub
- 4) Physical inability to exit the bathtub
- 5) Fetal damage in pregnant women
- 6) Unconsciousness and danger of drowning

- ▶ Since excessive water temperatures have a high potential for causing fetal damage during the early months of pregnancy, pregnant or possibly pregnant should consult a physician before using a bathtub equipped at higher temperatures.
- ▶ The use of drugs or alcoholic beverages before or during bath use may lead to unconsciousness with the possibility of drowning. Never use the bath while under the influence of alcohol, anticoagulants, stimulants, antihistamines, vasoconstrictors, vasodilators, hypnotics, narcotics or tranquilizers.
- ▶ Persons using medication should consult a physician before using a bath since medication may induce drowsiness while other medication may affect heart rate, blood pressure, and circulation.

**DANGER:** To reduce the risk of injury, enter and exit the bath slowly.

**Warning:** Never operate electrically connected devices in or within 5' of the bath. Never drop or insert any object into any opening within the hydrotherapy bath.

- ▶ To avoid the possibility of personal injury and discoloration of the acrylic surface, the inlet water temperature should not exceed 60°C (140°C).

**INSTALLER/OWNER BEARS ALL RESPONSIBILITY TO COMPLY WITH ALL STATE AND LOCAL CODES WHEN INSTALLING THIS PRODUCT**

**IMPORTANT! WHEN REQUIRED BY LOCAL CODES, INSTALL A RPZ (REDUCED PRESSURE ZONE) BACKFLOW PREVENTION DEVICE TO EACH FAUCET SUPPLY LINE.**

**Caution:** Do not use harsh abrasives or solvents for cleaning this unit.

- ▶ This product and its components are IAPMO approved.
- ▶ This product is intended for residential indoor use only. Tubs are only warranted for indoor installation in a climate controlled environment.
- ▶ Do not store tub at temperatures below 32 degrees Fahrenheit.

# SAVE THESE INSTRUCTIONS

## Table of Contents

Unpacking the Unit	5
Installation and Operation Guidelines	5
Rough-In Measurements	6
Freestanding Bath Installation Planning and Preparation	7
Freestanding Bath Installation Instructions	8
Cleaning Instructions	9
Warranty	11

### ATTENTION INSTALLER!

Access should be provided to the plumbing connections and should have a minimum size of 16" x 14" for installation and future servicing of the bathtub.

Hastings may not authorize any service unless clear access is available. Access from a crawlspace or incomplete access to all equipment may result in warranty claims being denied.

## Unpacking the Unit

1. Inspect the Carton.
2. If you note carton damage, take a picture, note the delivery receipt as damaged and contact the carrier immediately. **Do not install a damaged tub. Hastings or Clarke Products is not responsible for damage during transit.**
3. Immediately inspect the unit for damage even if there is no visible carton damage and immediately report any damage to the distributor or manufacturer customer service at 1-800-351-0038. Once the unit is installed and there is surface damage visible, we will assume it was caused by the installer. Installers are responsible for damage that occurs once the unit is set in place. Installation constitutes acceptance.
4. Remove all packaging material except for the protective foam covering. The protective foam covering was put on the tub to help eliminate abrasions due to handling and should not be removed until you are ready to inspect the tub just prior to installation.

# Installation and Operation Guidelines

Read all instructions before installing the tub. Installer/product owner is responsible for complying with all state and local codes. Warranty coverage will be void if the tub is not tested and installed as detailed in these instructions. Hastings strongly recommends using licensed professionals to install these products. **Warning: Certain cleaning products will permanently damage the cosmetic surface of the tub. Read cleaning product label carefully before using. Never use anything abrasive, aerosol sprays, or metal scrapers.**

## **BEFORE INSTALLING:**

Remove the protective plastic and inspect tub thoroughly. The protective plastic was put on the tub to help prevent abrasions/staining, and the cosmetic surface of the tub should be protected in some manner after the protective plastic is removed. A factory defect must be reported to the manufacturer before the tub is installed. Defects or damage claimed after installation will be excluded from the warranty.

**Important:** Measure the tub on site carefully. Hastings is NOT responsible for any preparatory labor or materials.

**Warning:** Solid surface bathtubs may be very heavy. Make sure you have adequate help to move/install the tub before beginning. Hastings is not responsible for handling damage.

## **ATTENTION INSTALLER!**

**This tub must be tested for leaks prior to installation. Failure to do so will void the warranty. This tub was tested at the factory and found to be fully operational and leak-free prior to shipping. Shipping, handling, and job site exposure may have deteriorated the tub's condition. It is the responsibility of the installer to thoroughly test the tub prior to installation.**

### **Water Test Procedures**

1. Place the tub on a level surface.
2. Seal the drain.
3. Fill the tub to the overflow.
4. Allow tub to stand for at least five minutes and then check for leaks.

**Always protect the tub from construction damage. Damage, including chips and scratches, incurred at the jobsite is excluded from the warranty, but may be repaired by a qualified individual at the owner's expense.**

**Important:** Proper waste and overflow (if applicable) installation is the responsibility of the installer. Clarke Products does not warrant leaks associated with improper waste and overflow installation.

## Rough-In Measurements for Freestanding Bathtubs

Item Number	Meas A	Meas B	Meas O	Slotted	Length	Width	Height	Dry	Gal to overflow
				Integral			to Deck	weight	
				Overflow			(D)	(lb)	
CHELSEA-60-TUB	9.8"	15.93"	17.18"	Yes	59.78"	31.86"	19.98"	225	67.5
CHELSEA-66-TUB	10.7"	16.9"	18.1"	Yes	65.9"	33.8"	21.2"	294	86
DUNE-TUB-59	10"	16"	18 ½" *	Yes	59"	32"	27 1/2"	263	72
DUNE-TUB-68	12 1/4 "	17"	19 ½" *	Yes	68"	34"	29"	347	93
BELLA-TUB-64	32 ½"	18"	15" *	Yes	63 3/4"	35 1/2"	22 1/2"	284	48
LUNAR-TUB-71	35 1/2"	15 3/4"	23"	Yes	71"	31 1/2"	25"	420	107
LUNAR-TUB-66	33"	16"	21"	Yes	66"	32"	23"	232	101
LUNAR-TUB-59	29.5"	16"	20"	Yes	59"	32"	23"	203	83
OVAL-TUB-58	8"	19"	16"	Yes	58"	36 1/2"	19 1/2"	155	71
SPARTA-TUB-66	33"	16"	17.4"	Yes	66"	32"	18	200	73

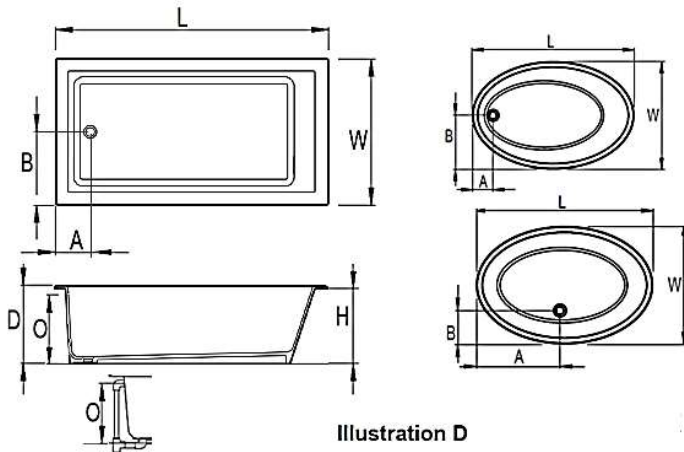

Illustration D

**Note: All specifications are within  $\pm \frac{1}{4}$ " tolerance. They are subject to change without notice. Hastings strongly recommends measuring your specific tub on site. Refer to Illustration A on next page for how measurements have been taken.**

### Installation Planning and Preparation

1. Determine the final location of the tub. The tub will sit on top of the finished floor but the drain (and overflow piping, if applicable) may sit **below** the finished floor. Tubs installed on a slab foundation may require extra effort to gain clearance for installation.
2. Ensure location is structurally sound and can bear the weight of the tub when filled with water. (Refer to page 6 for details regarding weight of tub & water capacity.)
3. Check to make sure the floor is level. An uneven floor may impede proper installation of the tub. Use a 5 or 6 foot level to determine if the floor is level. If not, calculate how much Structuralite or mortar/bedding material will be required to level the tub. **The entire tub floor must be fully supported.**

4. Insure there is a drain rough in the proper location to allow the necessary clearance.

**EZ-CLICK™ BATH TUB DRAIN WITH OVERFLOW**



SPECIFICATION SHEET

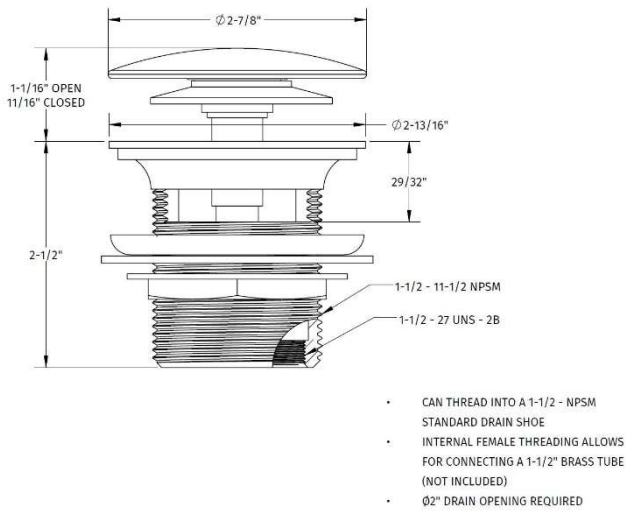

**SCENARIO 1: P TRAP DIRECTLY BELOW DRAIN USING EXTERNAL THREADS AND STRAIGHT FITTING**

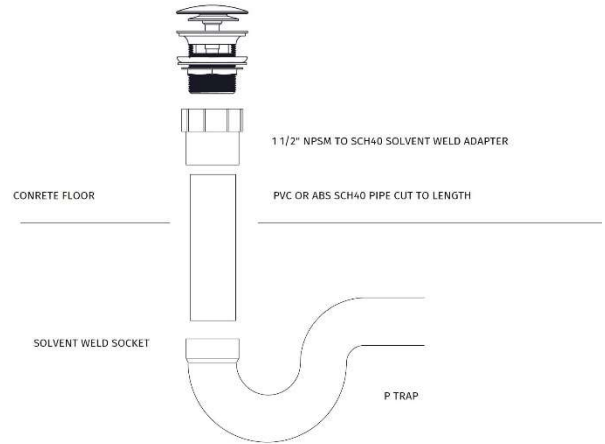

**SCENARIO 2A: OFFSET P TRAP USING EXTERNAL THREADS**

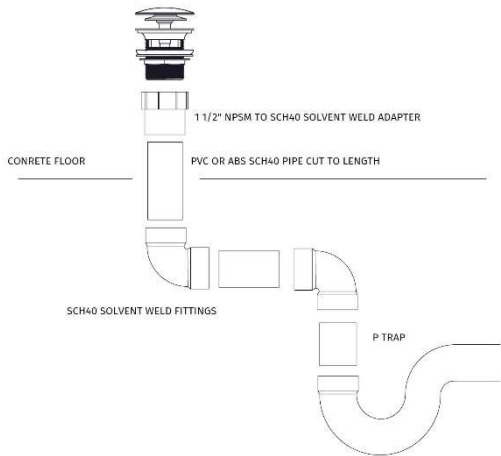

**SCENARIO 2B: OFFSET P TRAP USING EXTERNAL THREADS AND 90° DRAIN SHOE**

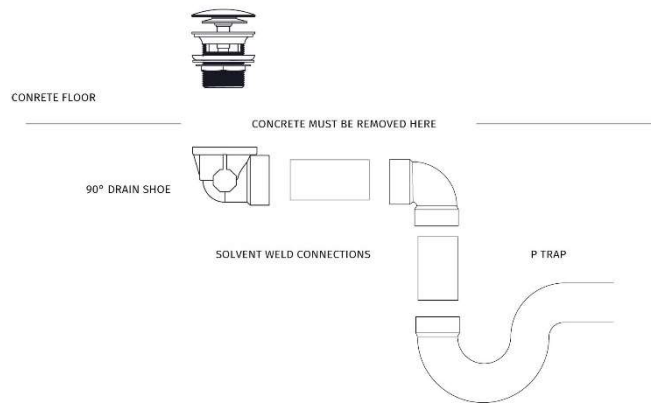

**SCENARIO 3: TAILPIECE WITH ISLAND TUB DRAIN ADAPTER**

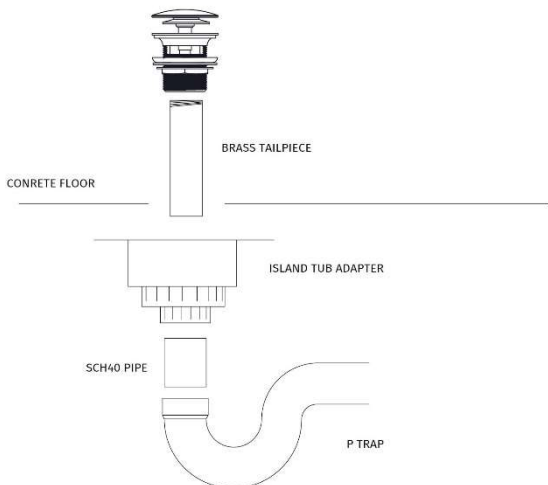

**SCENARIO 4: TAILPIECE WITH SLIP JOINT CONNECTION**

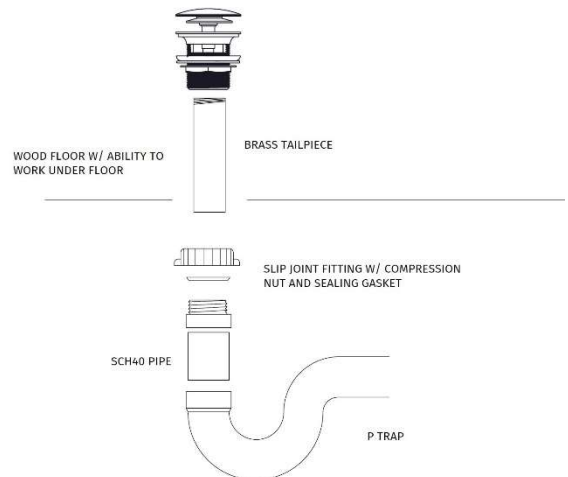

# Freestanding Bath Installation Instructions

1. Tip the tub over to install the drain and overflow if applicable. Use care not to damage the solid surface/acrylic finish by using suitable material to protect the finish of the tub.
2. For non-integral overflow tubs, install the drain and overflow per manufacturer's instructions. For integral overflow tubs, install the drain per manufacturer's instructions. We recommend the use of clear silicone to seal as plumber's putty can dry and crack, leaving opportunity for leaking. Plumber's putty may also discolor the tub or drain finish over time.
3. The tub bottom must be supported by a setting compound such as Structalite, Plaster of Paris or mortar. Fast curing materials are not recommended due to potential excessive shrinkage.

For those models with an integral supporting lip on the bottom of the tub, the setting compound should fill the area inside the integral supporting lip.

A sheet of plastic film both under and on top of the setting compound is recommended as a barrier.

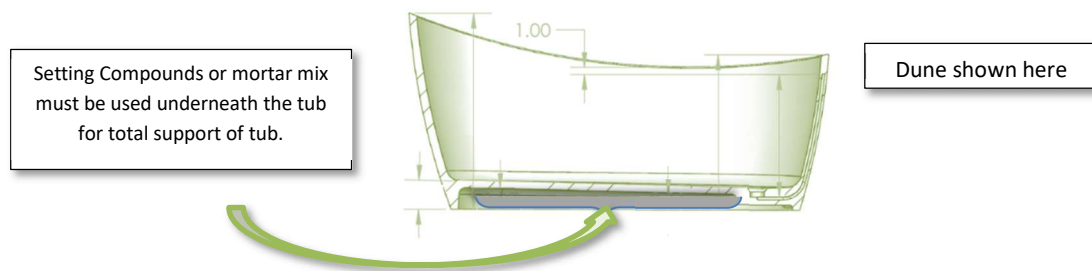

4. Put the bedding material in place and set the tub in place while the compound is still soft and will conform to the tub bottom. Avoid getting bedding material on the drain/overflow connections. The tub should be worked on into the compound. Partially filling the tub with water is sometimes used to help insure proper setting of the tub.
5. Verify the tub is level & drains properly before the setting material hardens.
6. Once the tub is set, make final plumbing connections as required.
7. If you are installing the spout or faucets on the deck of the tub, mark the proper location first. Drill a pilot hole from the solid surface/acrylic finished side and then use a properly sized hole saw to drill the holes from the solid surface/acrylic finished side.
8. Attach the remaining plumbing and clean all dirt and debris from the tub. Proper cleaning instructions can be found in the Cleaning and Maintenance section of these instructions.





## Cleaning and Maintenance

### Cleaning Instructions for Solid Surface Models

The cast surface of all Hastings Products solid surface is one of the highest quality surfaces available. The matte finish is design to provide an elegant, durable finish. It's hard, non-porous surface prevents dirt from accumulating and resists stains. Under normal use, the solid surface will retain its beauty with only a minimal amount of care. To maintain the elegant look follow these simple steps:

**Construction Debris:** Most construction debris can be removed with a mild detergent. More stubborn debris may be removed with denatured alcohol or Clorox Soft Scrub® cleaner. Plaster can be removed by carefully using a sharpened wooden stick. **Do not use metal scrapers, wire brushes, or other harsh abrasive tools.** Light scratches and dulled areas may be restored to original MATTE finish by lightly sanding the area with #320 dry grit sandpaper.

For polished surfaces wet and dry sanding and a polish compound may be necessary to restore the polish surface if damaged, contact customer service for more details.

Remove dust and dry dirt with a soft, damp cloth. To remove most stains, use 1 part bleach mixed with 10 parts water. Leave in place for 10 minutes, drain, and then rinse. Clean grease, oil, paint, or ink stains with isopropyl (rubbing) alcohol. Dry with a clean, soft cloth.

Avoid using razor blades or other sharp objects that might scratch the surface. Most minor scratches (up to 1/64") and cigarette burns can be removed by sanding the area with #320 dry grit sandpaper.

**For cracks and major surface damage caused during installation, call our service line (800) 351-0038 for information on how to make those repairs.**

Rust or greasy substances may be due to sediments in the water heater of the home. Drain/flush the water heater according to the manufacturer's instructions and clean the tub as described above.



## LIMITED WARRANTY

All Hastings Solid Surface Bathing Tubs are warranted in accordance with the following Limited Warranty:

Hastings Solid Surface Free Standing tubs are warranted against defects in material and workmanship from the date of the first consumer purchase.

Solid Surface warranty is 10 years for the surface/solid material of the tub itself. This Warranty shall apply to defective surfaces which crack, fade or blister.

The Warranty extends to the first consumer purchaser and not to subsequent owners, transferees or users other than the first purchaser. This warranty does not extend to products previously utilized as display models.

This Warranty shall apply to products installed and used only for indoor personal, family or household purposes and which are installed and maintained in accordance with Hastings recommended installation and maintenance procedures. This Warranty does not extend to defects or damage caused, in whole or in part, by any unauthorized or unreasonable use. No liability shall exist for incidental or consequential damages caused in whole or part by any defects in Hastings products. No warranty, expressed or implied, including any warranty of merchantability or fitness for a particular purpose, shall apply after the warranty period described above. Some states do not allow the exclusion or limitation of incidental or consequential damages or limitations on how long an implied warranty lasts. The above limitation may not apply to you.

In the event of a defect in material or workmanship of a Hastings Bath tub during the Warranty period, defective products will be repaired or replaced as Hastings, at its sole and absolute discretion, determines. However, Hastings shall not be liable for the expense for removing defective products or installing replacement products. In certain circumstances, some states do not allow the limitation of liability for removal, transportation and reinstallation expenses. The above limitation may not apply to you.

Only Hastings is authorized to perform its warranty obligation. If you wish to obtain performance of the Hastings warranty obligation you should contact Hastings, telephone number 800-351-0038. Other information about performance of the Hastings warranty obligation may be obtained at the same address and telephone number.

This Warranty gives you specific legal rights and you may also have other rights which vary from state to state.